

SKF



SKF TKTL 40

Instructions for use

ЗАО "Бепр АБ" (495) 727-22-72 promshop- biz@ya.ru

www.promshop.biz

Table of contents

EC Declaration of conformity.....	4
Safety recommendations.....	5
1. Introduction.....	6
2. Features	7
3. Technical data	8
4. Front panel and button description	10
5. Menu overview	13
5.1 Measurement Mode.....	13
5.2 IR CAM mode	14
5.2.1 Taking pictures	15
5.2.2 Taking Videos.....	15
5.3 IR measurement mode.....	15
5.4 DEWPOINT mode.....	16
5.5 Datalogger	16
5.6 Gallery	17
5.7 Settings.....	18
5.7.1 Languages	19
5.7.2 Date/Time	19
5.7.3 Units	19
5.7.4 Memory.....	20
5.7.5 Beeper.....	20
5.7.6 Auto screen-off	21
5.7.7 Auto power-off.....	21
5.7.8 System default setting	21
6. Measurement Settings.....	22
6.1 Emissivity set	23
6.2 Alarm High	23
6.3 Alarm Low	24
6.4 Laser	24
6.5 Auto Mode.....	24
6.6 Max/Min.....	25
6.7 Average/Dif.....	25
6.8 Ambient TEMP/% RH.....	25
6.9 Dewpoint/wet bulb.....	25
6.10 Contact temperature probe type K measurement	25
6.11 Color	26
7. Notes	27
8. Emissivity table.....	28

Original instructions

EC Declaration of conformity

We,

SKF Maintenance Products
Kelvinbaan 16
3439 MT Nieuwegein
The Netherlands

herewith declare that the following product:

SKF Infrared Thermometer TKTL 40

has been designed and manufactured in accordance with:
EMC DIRECTIVE 2004/108/EC as outlined in the harmonized
norm for

EN 55022:2006+A1:2007

EN 55024:1998+A1:2001+A2:2003

EN 61326-1:2006

EN 61326-2-1:2006

IEC 61326-1:2005

IEC 61326-2-1:2005

The laser is classified in accordance with the EU norm
EN 60825-1:1994/A2:2001/A1:2002

EUROPEAN ROHS DIRECTIVE 2011/65/EU

Nieuwegein, The Netherlands,
November 2013



Sébastien David
Manager Product Development and Quality



Safety recommendations

- Always read and follow the operating instructions for use.
- Never stare directly into the laser source.
- Never aim the laser beams into anyone's eyes.
- Never open the instrument.
- All repair work should be taken care of by an SKF repair shop.



1. Introduction

The SKF TKTL 40 is a portable, lightweight multi- functional instrument for safely measuring temperatures at a distance. Simply aim and pull the trigger and the temperature is shown on the display. Users can also measure contact temperatures using the probe supplied.

This feature rich instrument also has the facility to take pictures and videos, showing the temperature measurements. In addition, a number of environmental properties can also be measured and displayed.



2. Features

- 2.2" TFT LCD display
- 640 × 480 pixels digital camera
- Internal memory expandable to 8GB using Micro SD card
- Image (JPEG) and video (MP4)
- Humidity and Air Temperature
- Dual laser targeting
- Type-K thermocouple probe
- Adjustable emissivity
- High accuracy
- Fast response time
- Dewpoint temperature and Wet bulb temperature

Distance & Spot Size

As the distance (D) from the object increases, the spot size (S) of the area measured by TKTL 40 becomes larger.

The relationship between distance and each unit is listed below.

The spot size indicates 90% measured energy.

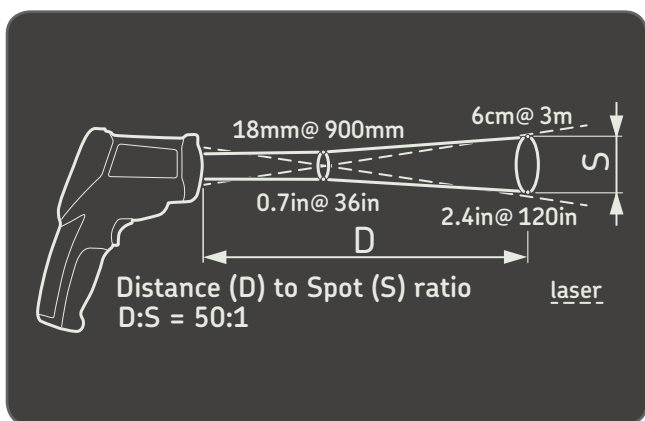

3. Technical data

General	
Display	2,2" 320 × 240 colour LCD with backlight
Displayed resolution	0,1° up to 1 000°, otherwise
Emissivity setting	0,10–1,00
Backlit display	Always on
Measurement modes	Min, max, average, differential, Probe/IR dual display datalogger
HVAC Functionalities	Wet Bulb, Dew point, Humidity, Air temperature
Alarm modes	High and low level alarm level with audible alarm
Photo and Video mode	640 × 480 Camera, Images (JPEG) & Video (3GP)
Memory	310 MB internal memory, expandable to 8GB using Micro SD card
PC Connection	Yes, Mini USB cable included
Laser Pointer	2 × built-in class 2 lasers, on/off
Maximum laser power	1 mW
Auto Switch Off	3 minutes, adjustable
Tripod Mount	1/4" BSW

Infrared Temperature Measurement	
Distance to Spot size (D:S)	50:1
Temperature range using infrared	–50 to +1 000 °C (–58 to +1 832 °F)
Accuracy	20 to 500 °C: ±1% of reading or 1 °C (1.8 °F) whichever is greater 500 to 1 000 °C: ±1,5% of reading –50 to +20 °C: ±3,5 °C (6.3 °F)
Response time	<300 ms
Spectral response	8–14 μm

Contact Probe Measurement	
Temperature using probe	–50 to +1 370 °C (–58 to +2 498 °F)
Probe compatibility	Type K
Probe supplied	TMDT 2-30, suitable for use up to 900 °C (1 650 °F)
Accuracy	0 to 1 370 °C: ±0,5% of reading ±1,5 °C (±2.7 °F) –50 to 0 °C: ±2,5 °C (4.5 °F)

Battery and Power	
Battery	1 × Rechargeable Li-ion Battery 3,7 V 1 400 mAh 5,2 W
Operation time	4 hours continuous use
Power Adapter	100–240 V/50–60 Hz AC Compact Charger with Europe, USA, UK and Australian plugs
Charging Time	2 hours with AC adapter

Size and Weight	
Product Dimensions	205 × 155 × 62 mm (8.1 × 6.1 × 2.4 in.)
Product Weight	500 g (1.1 lb)
Carrying Case dimensions	530 × 180 × 85 mm (20.9 × 7.0 × 3.4 in.)
Total weight (incl. case)	1,7 kg (3.8 lbs)

Operating Requirements	
Operating temperature	0 to 50 °C (32 to 120 °F)
Storage temperature	–10 to +60 °C (–4 to +150 °F)
Relative Humidity	10 to 90% RH non-condensing
IP rating	IP 40

Case contents	
1 × Infrared thermometer TKTL 40	
1 × Contact probe TMDT 2-30	
1 × AC battery charger	
1 × Mini tripod	
1 × Mini USB to USB connection cable	
1 × printed Instructions for use	

4. Front panel and button description

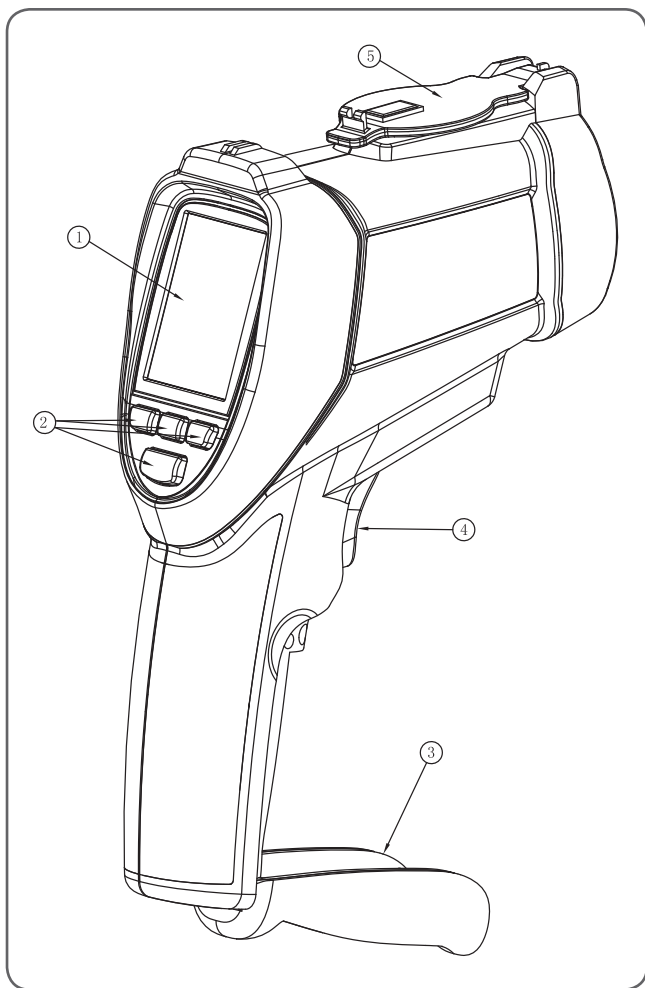

Item	Description
1	LCD Display
2	Buttons
3	Battery cover
4	Measurement trigger
5	Magnetic lens cover

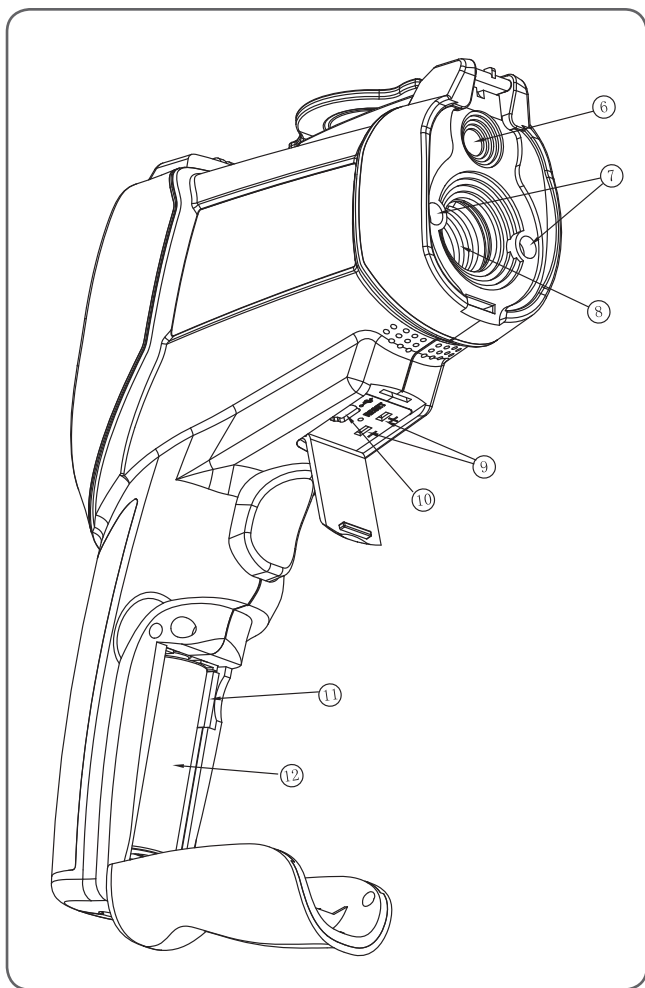

Item	Description
6	Visual camera
7	Lasers
8	IR sensor
9	Type-K thermocouple socket
10	Mini USB computer and power adapter connector
11	Micro SD memory card port
12	Battery

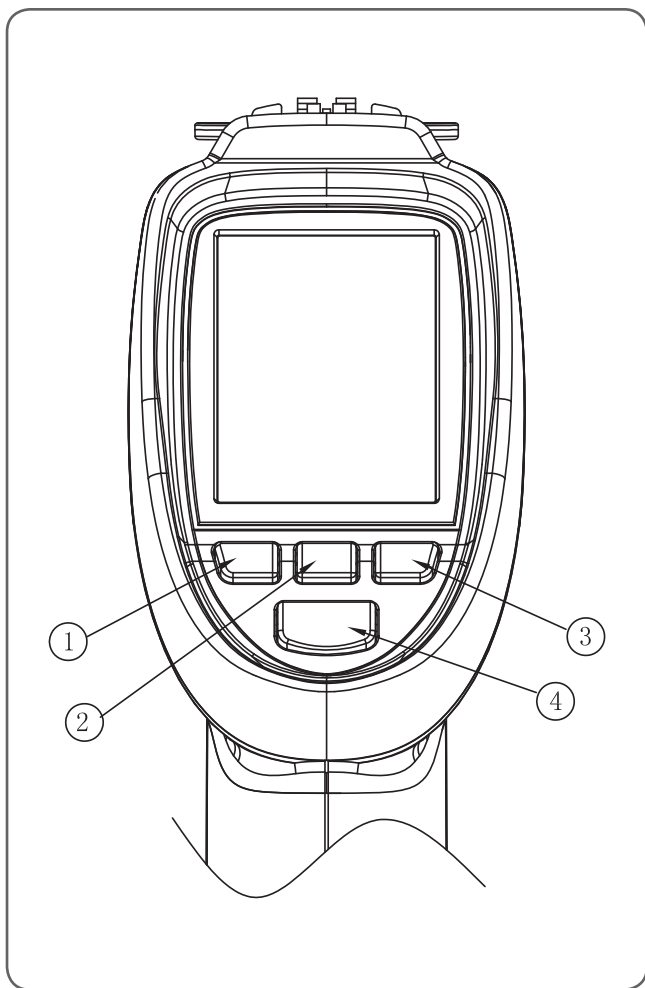

Item	Description
1	UP or Picture button
2	Power/Esc button
3	Down or video button
4	Mode/Enter button

5. Menu overview

Switching On the Camera:

- Press and hold the Power button until the LCD is on to turn On the camera.
- Press and hold the Power button until the LCD is off to turn Off the camera.











5.1 Measurement Mode

The TKTL 40 has six modes:

Press the ESC button to display the six modes. Use the UP or DOWN buttons to select a mode.



Item	Description
IR CAM	Measure the IR temperature and other parameters with a camera image
IR Measure	Measure the IR temperature and other parameters without a camera image
Dewpoint	Dewpoint visualization mode
Datalogger	Datalogger mode
Gallery	Display recorded pictures, datalogs and videos
Settings	Modify Camera Settings

Symbol	Description
	CAM mode
	IR mode
	DEWPOINT mode
	Laser
	Scan
	High alarm
	High alarm working
	Low alarm
	Low alarm working
	Hold

5.2 IR CAM mode

Used to measure IR temperature, air temperature, air humidity, dewpoint temperature and wet bulb temperature with camera. It can display the IR MAX temp., MIN temp., DIF temp., AVG temp. Press and hold the trigger to measure the temperature. This allows taking pictures and videos.

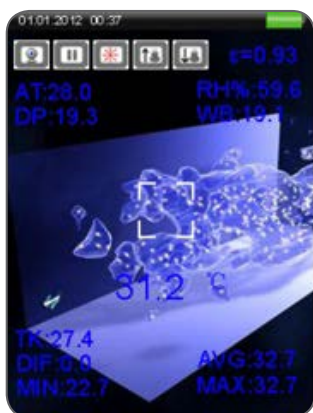

5.2.1 Taking pictures

Press the ▲ button to take a picture, then press the ▲ button again to save the picture or delete the picture with the ▼ button.



5.2.2 Taking Videos

Press the ▼ button to start recording a video.

Press the ▼ button again to stop the recording and save the video.

Zoom function:

Long press the ▼ button to zoom out.

Long press the ▲ button to zoom in.

5.3 IR measurement mode

Used to measure IR temperature, air temperature, air humidity, dewpoint temperature and wet bulb temperature without camera.

It can display the IR MAX temp., MIN temp., DIF temp., AVG temp.

Press and hold the trigger to measure the temperature.



5.4 DEWPOINT mode

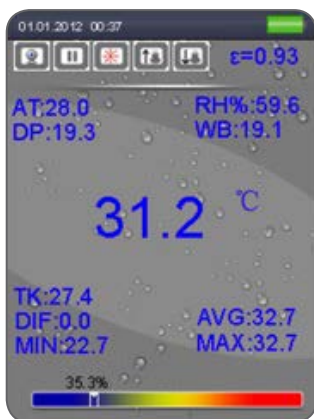

Press and hold trigger to start measuring.



The percentage shows how close the measured IR temperature is from the Dewpoint temperature. When the scale is at 100%, the measured IR temperature is at the dewpoint level.

5.5 Datalogger

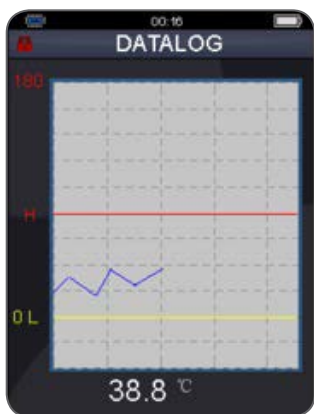

Press the trigger once to start the datalogger measurements. Press the ESC button to quit the DATALOGGER mode and automatically save the data to the internal memory or memory card.

Note:

Define the measurement recording interval in the logs time setting. The logs can be visualized from the gallery or downloaded on a computer with the USB connection.

5.6 Gallery

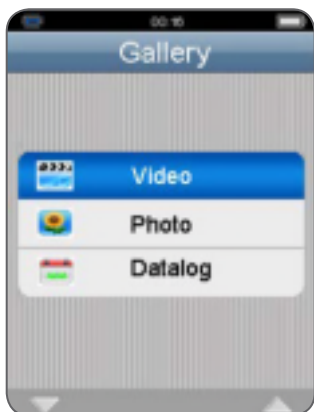

Item	Description
Video	Play the saved videos
Picture	Display the saved pictures
Logs	Display the data logs

- Press the UP and DOWN buttons to select picture, video or Logs. Then press the ENTER button.
- **Video playback:**
Press the ENTER button to pause or play
Press the Esc button to exit.









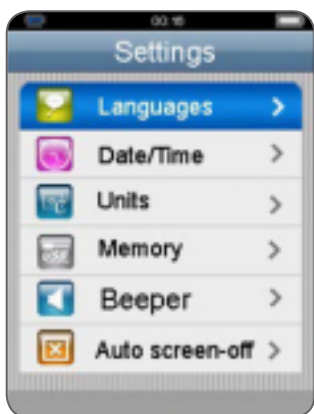

- **Photo view:**
Press the ENTER button to open the menu, press the UP button to previous picture file, press the DOWN button to next picture file.



- **Delete a picture:**
Keep the ENTER button pressed until the delete menu appears.
- **Delete a video:**
Keep the ENTER button pressed on the file list until the delete menu appears.

5.7 Settings



Symbol	Settings
	Languages
	Date/Time
	Temperature Units
	Memory
	Beep when a button is pressed
	Auto screen-off
	Auto power-off
	System default setting

5.7.1 Languages



Press the UP and DOWN button to select the language, press ESC button to esc and save the select the language.

5.7.2 Date/Time



Press the UP and DOWN button to select the date or time, then press the ENTER button to enter, press the UP and DOWN button to adjust the value, press the ESC button to esc and save.

5.7.3 Units



Press the UP and DOWN button to select the units, press the ESC button to esc and save.

5.7.4 Memory

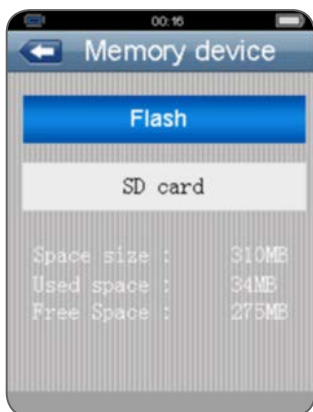

Press the UP and DOWN button to select the Memory device, press the ENTER button to enter. The internal memory or the memory card can be selected.

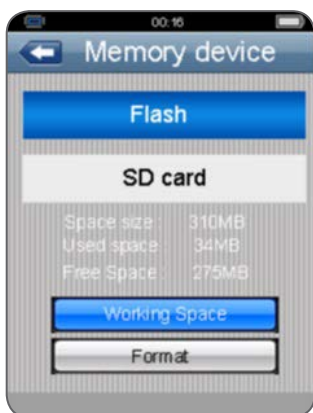

5.7.5 Beeper

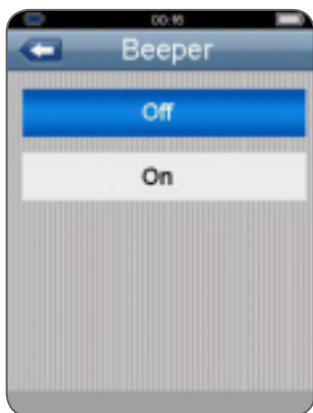

Press the UP and DOWN button to select the beeper status, press ESC button to esc and save the select the beeper status.

5.7.6 Auto screen-off

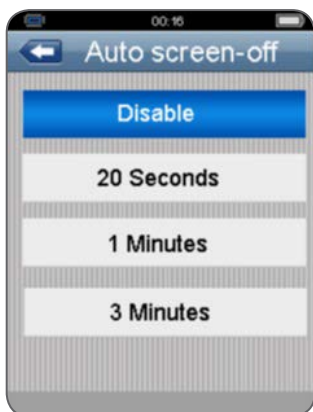

Press the UP and DOWN button to select the screen auto off time or disable the function.
Press the ESC button to esc and save.

5.7.7 Auto power-off

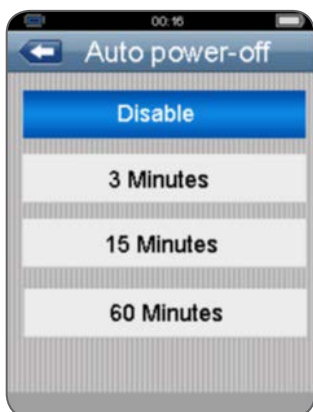

Press the UP and DOWN button to select the auto power off time or never auto power off, press the ESC button to esc and save.

5.7.8 System default setting

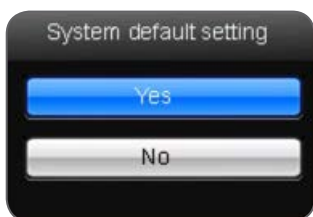

Select Yes to reset all settings.
The stored data will not be affected.

6. Measurement Settings

On any mode, press the ENTER button into the menu.

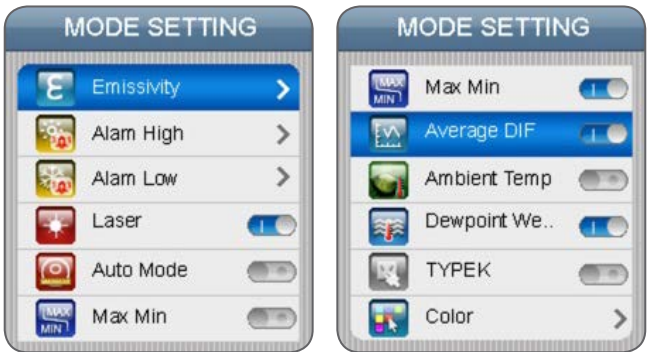

Item	Description
Emissivity	Set the emissivity
Alarm High	Set a High temperature alarm
Alarm Low	Set a Low temperature alarm
Laser	Enable or disable the laser
Auto Mode	Continuous measurement when enabled
Max/Min	Display the max. or min. IR temperature
Average/Dif	Display the average or difference of IR temp.
Ambient temp /% RH	Display the air temperature and relative humidity
Dewpoint/ wet bulb	Display the dewpoint and wet bulb temperature
Type k	Enable or disable the type-K input
Color	Font color

6.1 Emissivity set

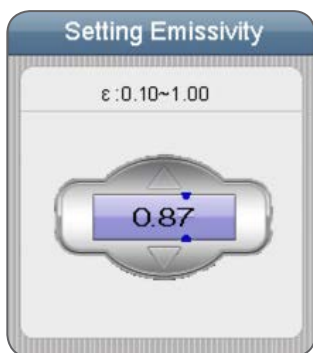

ON the first Item, press the ENTER button to adjust emissivity, press the UP and DOWN button to adjust the value, then press the ENTER button to confirm. Press the UP and DOWN button to select the emissivities of the materials, press the ESC button to esc and save.

6.2 Alarm High



Press the ENTER button on the first row and use the UP and DOWN button to adjust the value. Press the ENTER button to confirm, press the ESC button to esc and save.

6.3 Alarm Low

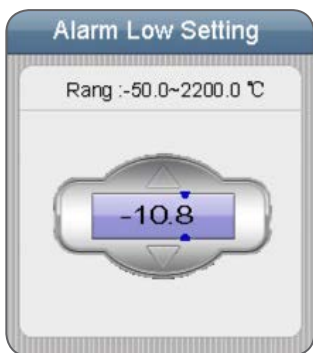

Press the ENTER button on the first row and use the UP and DOWN button to adjust value. Press the ENTER button to confirm, press the ESC button to esc and save.

6.4 Laser



Enable



Disable

Press the ENTER button to enable or disable laser.
Press the ESC button save.

6.5 Auto Mode

Activate to enable continuous measurement of the IR temperature.

6.6 Max/Min



Enable



Disable

Press the ENTER button to enable or disable.

Press the ESC button to quit and save.

6.7 Average/Dif



Enable



Disable

Press the ENTER button to enable or disable.

Press the ESC button to quit and save.

6.8 Ambient TEMP/% RH



Enable



Disable

Press the ENTER button to enable or disable.

Press the ESC button to quit and save.

6.9 Dewpoint/wet bulb



Enable



Disable

Press the ENTER button to enable or disable.

Press the ESC button to quit and save.

6.10 Contact temperature probe type K measurement



Enable



Disable

Press the ENTER button to enable or disable.

Press the ESC button to quit and save.

Note:

When a K-type probe is connected to the TKTL 40, the measured temperature will be displayed automatically.

6.11 Color



Choose a font color.

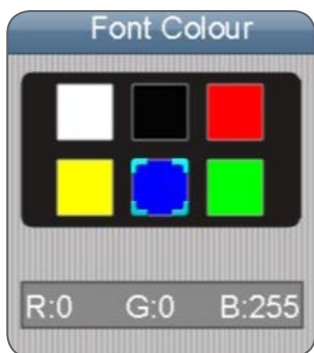

7. Notes

- **How does Infrared work?**

Infrared thermometers measure the surface temperature of an object. The unit's optics sense emitted, reflected, and transmitted energy, which is collected and focused onto a detector.

The unit's electronics translate the information into a temperature reading, which is displayed on the unit.

The laser is used for aiming purpose only.

- **Field of View**

Make sure the target is larger than the unit's spot size.

The smaller the target, the closer you should be.

When accuracy is critical, make sure the target is at least twice as large as the spot size.

- **Distance & Spot Size**

As the distance (D) from the object increases, the spot size (S) of the area measured by the unit becomes larger.

See figure at the beginning of this manual.

- **Locating a hot Spot**

To find a hot spot aim the thermometer outside the area of interest, then scan across with an up and down motion until you locate hot spot.

- **Reminders**

- Do not use the unit to measure shiny or polished metal surfaces (stainless steel, aluminum, etc.). See Emissivity

- The unit can not measure through transparent surfaces such as glass. It will measure the surface temperature of the glass instead.

- Steam, dust, smoke, etc., can prevent accurate measurement by obstructing the unit's optics.

- **Emissivity**

Emissivity is a term used to describe the energy-emitting characteristics of materials.

Most (90% of typical applications) organic materials and painted or oxidized surfaces have an emissivity of 0.95 (pre-set in the unit).

Inaccurate readings will result from measuring shiny or polished metal surfaces. To compensate, cover the surface to be measured with masking tape or black paint. Allow time for the tape to reach the same temperature as the material underneath it.

Measure the temperature of the tape or painted surface.

8. Emissivity table

Substance	Thermal emissivity	Substance	Thermal emissivity
Asphalt	0,90 to 0,98	Cloth (black)	0,98
Concrete	0,94	Human skin	0,98
Cement	0,96	Lather	0,75 to 0,80
Sand	0,90	Charcoal (powder)	0,96
Earth	0,92 to 0,96	Lacquer	0,80 to 0,95
Water	0,92 to 0,96	Lacquer (matt)	0,97
Ice	0,96 to 0,98	Rubber (black)	0,94
Snow	0,83	Plastic	0,85 to 0,95
Glass	0,90 to 0,95	Timber	0,90
Ceramic	0,90 to 0,94	Paper	0,70 to 0,94
Marble	0,94	Chromium oxides	0,81
Plaster	0,80 to 0,90	Copper oxides	0,78
Mortar	0,89 to 0,91	Iron oxides	0,78 to 0,82
Brick	0,93 to 0,96	Textiles	0,90

ЗАО "Бепр АБ" (495) 727-22-72 promshop- biz@ya.ru

www.promshop.biz

The contents of this publication are the copyright of the publisher and may not be reproduced (even extracts) unless prior written permission is granted. Every care has been taken to ensure the accuracy of the information contained in this publication but no liability can be accepted for any loss or damage whether direct, indirect or consequential arising out of the use of the information contained herein.

SKF Maintenance Products

www.mapro.skf.com
www.skf.com/mount

MP5427EN

