

$d_{min} - d_{max}$	TMIC C7-8	TMIC C10-12	TMIC C12-15	TMIC C17-20	TMIC C22-28
mm - mm	7 - 8	10 - 12	12 - 15	17 - 20	22 - 28
in - in	0.28 - 0.31	0.39 - 0.47	0.47 - 0.59	0.67 - 0.79	0.87 - 1.1
	607 - 638 628/7 - 630/8	6000 - 6301 61800 - 61801 16000 - 16101	6001 - 6302 61801 - 16002 16101	6003 - 6404 61803 - 16004	6005 - 6405 61805 - 16005 62/22 - 63/28
	628/7 - 638	61800 - 6301	61801 - 62302	61803 - 62304	61805 - 62305
	127 - 108	1200 - 2301	1201 - 2302	1203 - 2304	1205 - 2305
		3200 - 5201	3201 - 3302	3203 - 3204	3205, 3305
				22205/20	22205, 21305

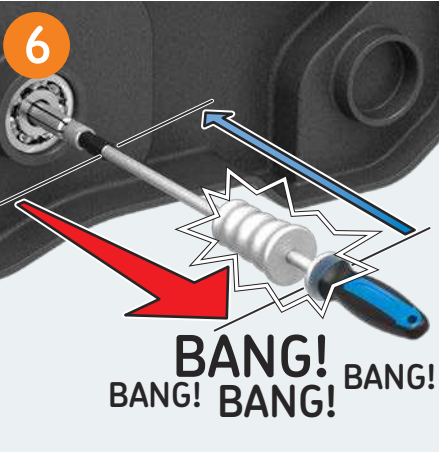
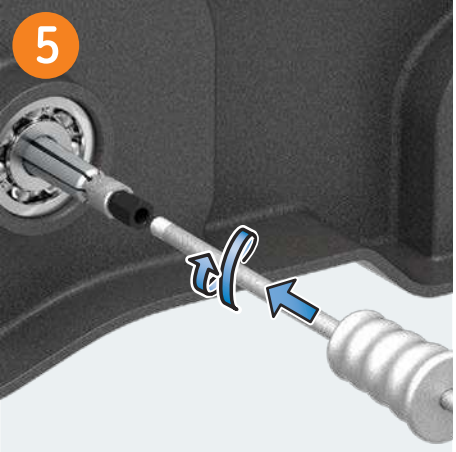
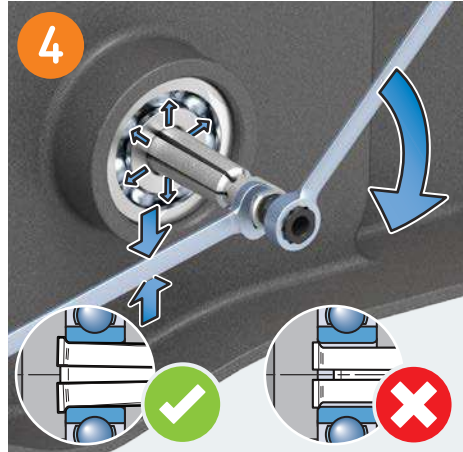
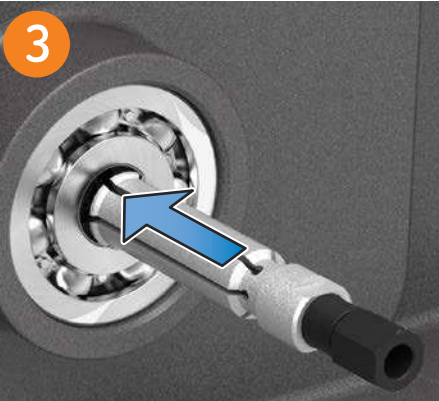
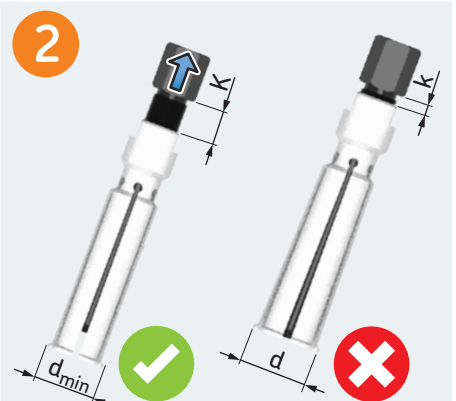
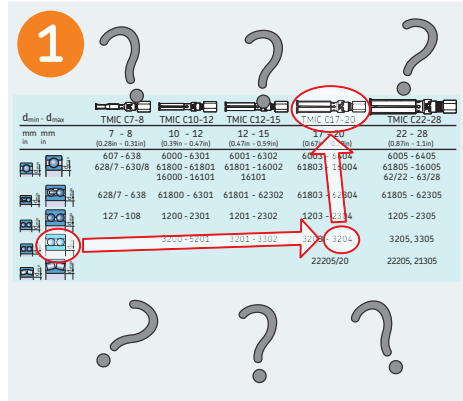

The contents of this publication are the copyright of the publisher and may not be reproduced (even extracts) unless prior written permission is granted. Every care has been taken to ensure the accuracy of the information contained in this publication but no liability can be accepted for any loss or damage whether direct, indirect or consequential arising out of the use of the information contained herein.

Le contenu de cette publication est soumis au copyright de l'éditeur et sa reproduction, même partielle, est interdite sans autorisation écrite préalable. Le plus grand soin a été apporté à l'exactitude des informations données dans cette publication mais SKF décline toute responsabilité pour les pertes ou dommages directs ou indirects découlant de l'utilisation du contenu du présent document.

Nachdruck, auch auszugsweise, nur mit unserer vorherigen schriftlichen Genehmigung gestattet. Die Angaben in dieser Druckschrift wurden mit größter Sorgfalt auf ihre Richtigkeit hin überprüft. Trotzdem kann keine Haftung für Verluste oder Schäden irgendwelcher Art übernommen werden, die sich mittelbar oder unmittelbar aus der Verwendung der hier enthaltenen Informationen ergeben.

El contenido de esta publicación es propiedad de los editores y no puede reproducirse (incluso parcialmente) sin autorización previa por escrito. Se ha tenido el máximo cuidado para garantizar la exactitud de la información contenida en esta publicación, pero no se acepta ninguna responsabilidad por pérdidas o daños, ya sean directos, indirectos o consecuentes, que se produzcan como resultado del uso de dicha información.

La riproduzione, anche parziale, del contenuto di questa pubblicazione è consentita soltanto previa autorizzazione scritta della SKF. Nella stesura è stata dedicata la massima attenzione al fine di assicurare l'accuratezza dei dati, tuttavia non si possono accettare responsabilità per eventuali errori od omissioni, nonché per danni o perdite diretti o indiretti derivanti dall'uso delle informazioni qui contenute.

O conteúdo desta publicação é de direito autoral do editor e não pode ser reproduzido (nem mesmo parcialmente), a não ser com permissão prévia por escrito. Todo cuidado foi tomado para assegurar a precisão das informações contidas nesta publicação, mas nenhuma responsabilidade pode ser aceita por qualquer perda ou dano, seja direto, indireto ou consequente como resultado do uso das informações aqui contidas.

本出版物内容的著作权归出版者所有且未经事先书面许可不得被复制(甚至引用)。我们已采取了一切注意措施以确定本出版物包含的信息准确无误,但我们不对因使用此等信息而产生的任何损失或损害承担任何责任,不论此等责任是直接、间接或附随性的。

Содержание этой публикации является собственностью издателя и не может быть воспроизведено (даже частично) без предварительного письменного разрешения. Несмотря на то, что были приняты все меры по обеспечению точности информации, содержащейся в настоящем издании, издатель не несет ответственности за любой ущерб, прямой или косвенный, вытекающий из использования вышеуказанной информации.



skf.com | mapro.skf.com | skf.com/mount

© SKF is a registered trademark of the SKF Group.

© SKF Group 2017

MP5445 · 2017/11

	A <sub>max</sub>	L <sub>max</sub>	H <sub>max</sub>	G <sub>max</sub>
	mm	mm	mm	mm
	in	in	in	in
TMIC C7-8	3 0.1	54 2.1	13,3 0.5	86,5 3.4
TMIC C10-12	3 0.1	56 2.2	46,5 1.8	89,5 3.5
TMIC C12-15	4,0 0.2	62 2.4	54 2.1	112 4.4
TMIC C17-20	5,3 0.2	70 2.8	59 2.3	106 4.1
TMIC C22-28	6,7 0.26	90 3.5	90 3.5	135 5.3

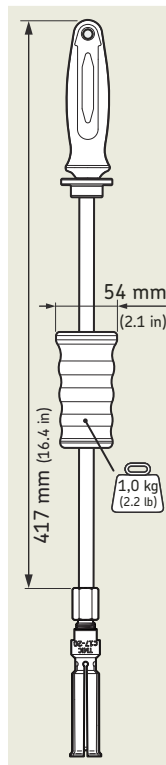

	P	Q
	mm (in)	mm (in)
TMIC C7-8	11 (7/16")	14 (9/16")
TMIC C10-12	11 (7/16")	14 (9/16")
TMIC C12-15	14 (9/16")	14 (9/16")
TMIC C17-20	14 (9/16")	14 (9/16")
TMIC C22-28	17 (11/16")	17 (11/16")

	P	Q
	mm (in)	mm (in)
TMIC C7-8	11 (7/16")	14 (9/16")
TMIC C10-12	11 (7/16")	14 (9/16")
TMIC C12-15	14 (9/16")	14 (9/16")
TMIC C17-20	14 (9/16")	14 (9/16")
TMIC C22-28	17 (11/16")	17 (11/16")

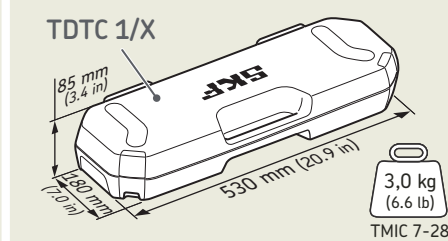

TMIC C7-8	TMIC C10-12
TMIC C12-15	TMIC C17-20
TMIC C22-28	TMMX 210
TMIP S1	

# SKF TMIC 7-28



Instructions for use  
Mode d'emploi  
Bedienungsanleitung  
Instrucciones de uso

Manuale d'istruzioni  
Instruções de uso  
使用说明书  
Инструкция по эксплуатации