

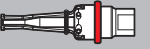

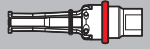









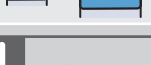

| |  TMIP E7-9 |  TMIP E10-12 |  TMIP E15-17 |  TMIP E20-28 |
|---|---|---|---|---|
| $d_{min} - d_{max}$ | 7 (0.28in) - 9 (0.35in) | 10 (0.39in) - 12 (0.47in) | 15 (0.59in) - 17 (0.67in) | 20 (0.79in) - 28 (1.1in) |
|  | 607 - 629 618/7 - 619/9 | 6000 - 6301 16000 - 16101 | 6002 - 6403 16002 - 16003 | 6004 - 6405 16004 - 16005 62/22 - 63/28 |
|  | 127 - 129 | 1200 - 2301 | 1202 - 2303 | 1204 - 2305 |
|  | | 3200 - 5201 | 3202 - 3303 | 3204 - 3305 |
|  | | 4200 - 4301 | 4202 - 4303 | 4204 - 4305 |
|  | | | | 22205/20-21305 |

1

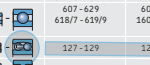
| | TMIP E7-9 | TMIP E10-12 | TMIP E15-17 | TMIP E20-28 |
|---|----------------------------|------------------------------|------------------------------|---|
| $d_{min} - d_{max}$ | 7 (0.28in) - 9 (0.35in) | 10 (0.39in) - 12 (0.47in) | 15 (0.59in) - 17 (0.67in) | 20 (0.79in) - 28 (1.1in) |
|  | 607 - 629 618/7 - 619/9 | 6000 - 6301 16000 - 16101 | 6002 - 6403 16002 - 16003 | 6004 - 6405 16004 - 16005 62/22 - 63/28 |
|  | 127 - 129 | 1200 - 2301 | 1202 - 2303 | 1204 - 2305 |
|  | | 3200 - 5201 | 3202 - 3303 | 3204 - 3305 |
|  | | 4200 - 4301 | 4202 - 4303 | 4204 - 4305 |
|  | | | | 22205/20-21305 |

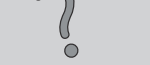

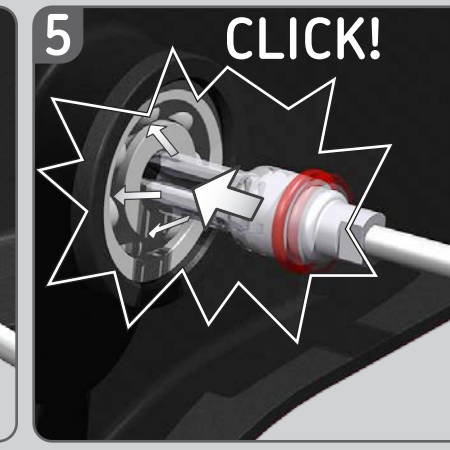
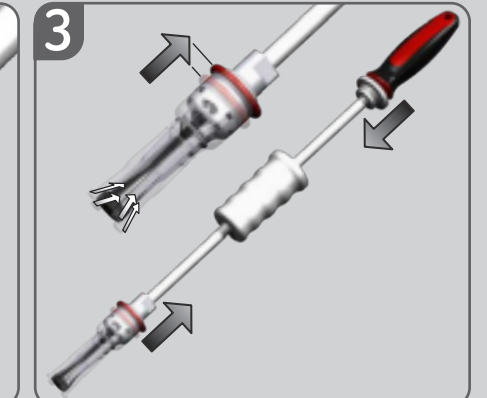
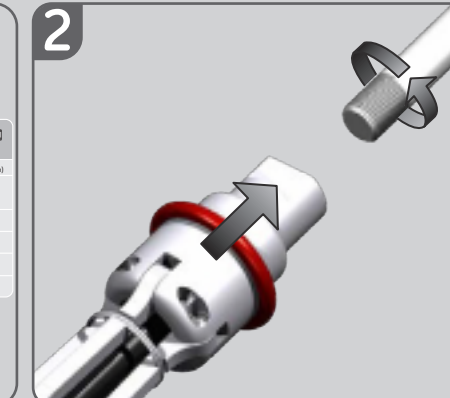
The contents of this publication are the copyright of the publisher and may not be reproduced (even extracts) unless prior written permission is granted. Every care has been taken to ensure the accuracy of the information contained in this publication but no liability can be accepted for any loss or damage whether direct, indirect or consequential arising out of the use of the information contained herein.

Le contenu de cette publication est soumis au copyright de l'éditeur et sa reproduction, même partielle, est interdite sans autorisation écrite préalable. Le plus grand soin a été apporté à l'exactitude des informations données dans cette publication mais SKF décline toute responsabilité pour les pertes ou dommages directs ou indirects découlant de l'utilisation du contenu du présent document.

Nachdruck, auch auszugsweise, nur mit unserer vorherigen schriftlichen Genehmigung gestattet. Die Angaben in dieser Druckschrift wurden mit größter Sorgfalt auf ihre Richtigkeit hin überprüft. Trotzdem kann keine Haftung für Verluste oder Schäden irgendwelcher Art übernommen werden, die sich mittelbar oder unmittelbar aus der Verwendung der hier enthaltenen Informationen ergeben.

El contenido de esta publicación es propiedad de los editores y no puede reproducirse (incluso parcialmente) sin autorización previa por escrito. Se ha tenido el máximo cuidado para garantizar la exactitud de la información contenida en esta publicación, pero no se acepta ninguna responsabilidad por pérdidas o daños, ya sean directos, indirectos o consecuentes, que se produzcan como resultado del uso de dicha información.

La riproduzione, anche parziale, del contenuto di questa pubblicazione è consentita soltanto previa autorizzazione scritta della SKF. Nella stesura è stata dedicata la massima attenzione al fine di assicurare l'accuratezza dei dati, tuttavia non si possono accettare responsabilità per eventuali errori od omissioni, nonché per danni o perdite diretti o indiretti derivanti dall'uso delle informazioni qui contenute.

Eftertryck – även i utdrag – får ske endast med SKF:s skriftliga medgivande i förväg. Vissa bilder används under licens från Shutterstock.com. Uppgifterna i denna trycksak har kontrollerats med största noggrannhet, men SKF kan inte påta sig något ansvar för eventuell förlust eller skada, direkt, indirekt eller som en konsekvens av användningen av informationen i denna trycksak.

De inhoud van deze publicatie is auteursrechtelijk beschermd en mag niet worden overgenomen (zelfs niet gedeeltelijk) tenzij schriftelijke toestemming is gegeven. Elke zorgvuldigheid is genomen om de nauwkeurigheid van de informatie in deze publicatie te verzekeren maar geen aansprakelijkheid kan voor om het even welke verlies of schade worden aanvaard die direct, indirect of volgend uit het gebruik van informatie uit deze publicatie volgt.

O conteúdo desta publicação é de direito autoral do editor e não pode ser reproduzido (nem mesmo parcialmente), a não ser com permissão prévia por escrito. Todo cuidado foi tomado para assegurar a precisão das informações contidas nesta publicação, mas nenhuma responsabilidade pode ser aceita por qualquer perda ou dano, seja direto, indireto ou consequente, como resultado do uso das informações aqui contidas.

本出版物内容的著作权归出版者所有且未经事先书面许可不得被复制（甚至引用）。我们已采取了一切注意措施以确认本出版物包含的信息准确无误，但我们不对因使用此等信息而产生的任何损失或损害承担任何责任，不论此等责任是直接、间接或附随性的。

Содержание этой публикации является собственностью издателя и не может быть воспроизведено (даже частично) без предварительного письменного разрешения. Несмотря на то, что были приняты все меры по обеспечению точности информации, содержащейся в настоящем издании, издатель не несет ответственности за любой ущерб, прямой или косвенный, вытекающий из использования вышеуказанной информации.



SKF Maintenance Products

www.mapro.skf.com
www.skf.com/mount

MP5337

© SKF is a registered trademark of the SKF Group.
© SKF Group 2013/04

| | A _{max} | | L _{max} | | H | | G | |
|-------------|------------------|------|------------------|-----|----|-----|-----|-----|
| | mm | in | mm | in | mm | in | mm | in |
| TMIP E7-9 | 6 | 0.24 | 39 | 1.5 | 10 | 0.4 | 91 | 3.6 |
| TMIP E10-12 | 6 | 0.24 | 45 | 1.8 | 11 | 0.4 | 91 | 3.6 |
| TMIP E15-17 | 7,5 | 0.29 | 55 | 2.2 | 18 | 0.7 | 118 | 4.6 |
| TMIP E20-28 | 10 | 0.4 | 60 | 2.4 | 24 | 0.9 | 127 | 5.0 |



SKF TMIP 7-28

Instructions for use
Mode d'emploi
Bedienungsanleitung
Instrucciones de uso
Manuale d'istruzioni

Bruksanvisning
Gebruiksaanwijzing
Instruções de uso
使用说明书
Инструкция по эксплуатации